

Crawler Kit for the Boe-Bot™ Robot (#30055)

The Crawler Kit

This kit allows your Parallax Boe-Bot™ Robot to walk on six legs. Assembly takes approximately 60 minutes to complete. Before getting started, take an inventory of the parts in your kit. Use **Fig #1** to identify each part to the parts list. Once you have inventoried your kit, proceed to **Step #1**. Parallax Boe-Bot robot (#28132) is sold separately



Recommended Tools

- Small needle nosed pliers
- Phillips #1 point screwdriver
- A sharp-tipped hobby knife, such as an X-Acto® knife -OR- A hand drill with 7/64"(2.8 mm) bit

WARNING!

DO NOT use electric screwdrivers with this kit. Please assemble using hand tools only to avoid damaging your Crawler.



Parts List

Item	Qty	Description
A	(2)	Crawler Sides
B	(2)	Servo horns
C	(4)	Legs
D	(6)	Rubber feet
E	(14)	Nylon washers
F	(2)	3 mm (1/8") Nylon Spacer
G	(4)	Push Arms
H	(2)	19 mm (3/4") Nylon Standoffs
I	(4)	25 mm (1") Nylon Standoff
J	(2)	M3x18 Phillips Pan Head Screw
K	(10)	M3x12 Phillips Pan Head Screw
L	(6)	M3x10 Phillips Pan Head Screw
M	(6)	M3 Hex Nut
N	(6)	M3 nylon insert locknuts
O	(2)	Middle Leg
P	(6)	M3x6 Phillips Pan Head Screw
Q	(12)	Plastic Screw Covers

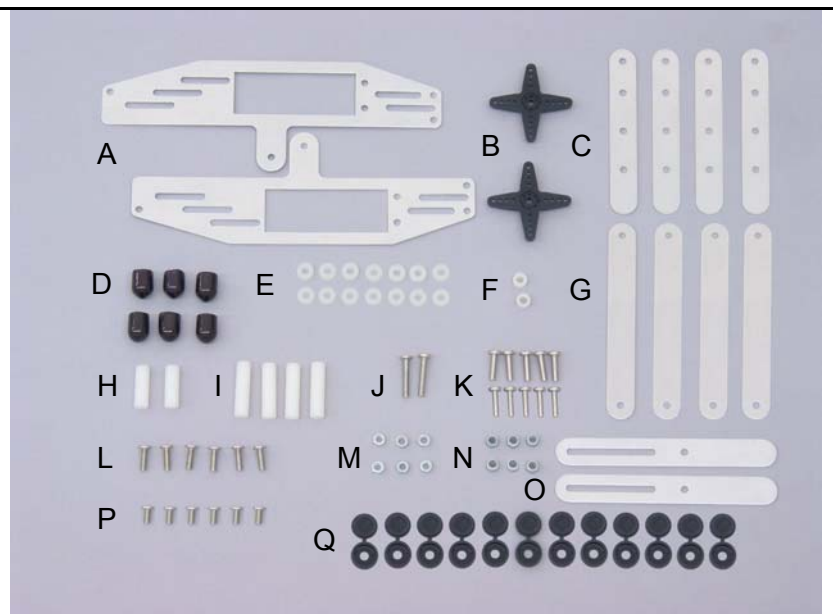
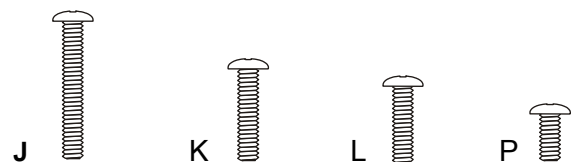

Fig #1



Step #1 Assembling the Crawler Sides

Item	Qty	Description
(A)	(2)	Crawler Sides
(E)	(2)	Nylon Washers
(H)	(2)	19 mm (3/4") Nylon Standoffs
(I)	(4)	25 mm (1") Nylon Standoffs
(K)	(4)	M3x12 Phillips Pan Head Screws
(L)	(2)	M3x10 Phillips Pan Head Screws

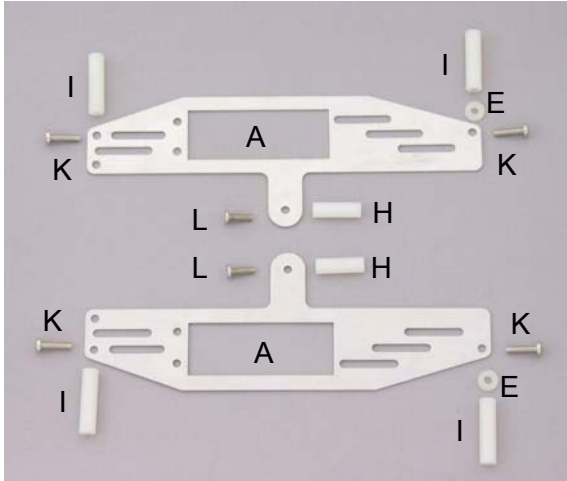

Fig #2

Use **Fig #2** as a guide to install the Nylon standoffs (H & I) using the screws (K) to the Crawler sides (A). The shorter standoffs (H) go to the center, and the longer standoffs (I) are mounted to the left and right. Tighten screws firmly.

Each side panel should be a mirror image of the other. Before moving on position the pieces exactly as they appear in **Fig #3** and double check your work and proceed to **Step #2**.

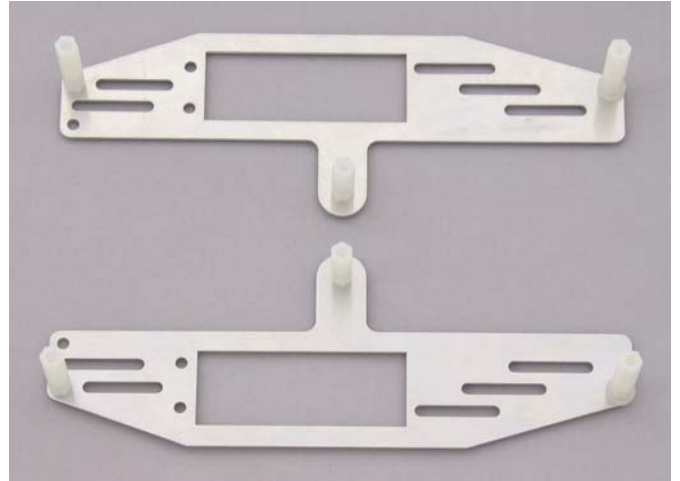

Fig #3

Step #2 Installing the Legs

Item	Qty	Description
(C)	(4)	Legs
(K)	(4)	M3x12 Phillips Pan Head Screws
(Q)	(4)	Plastic Screw Covers

Use **Fig #4** as a guide to install Legs. Insert screws (K) through screw covers (Q) and middle hole of Legs (C). Screw into standoffs (I). Tighten until leg can just rotate freely but is not sloppy. Before continuing, position the pieces exactly as they appear in **Fig #5**. Double check your work and then proceed to **Step #3**.

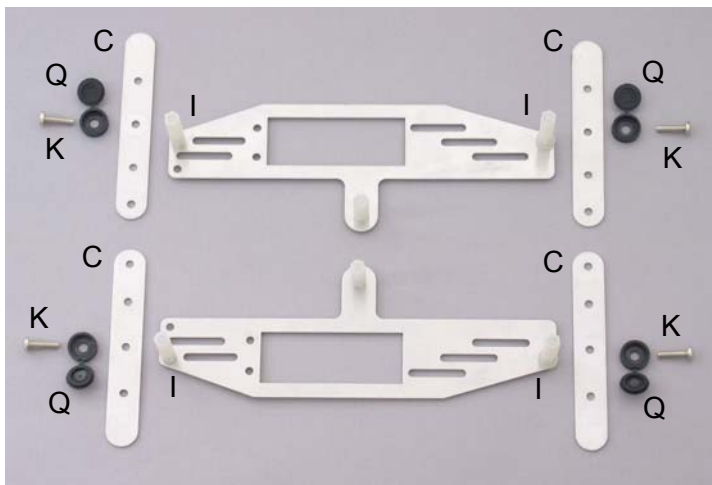

Fig #4



Fig #5

Step #3 Drilling the Servo Horns

Item	Qty	Description
(B)	(2)	Servo Horns

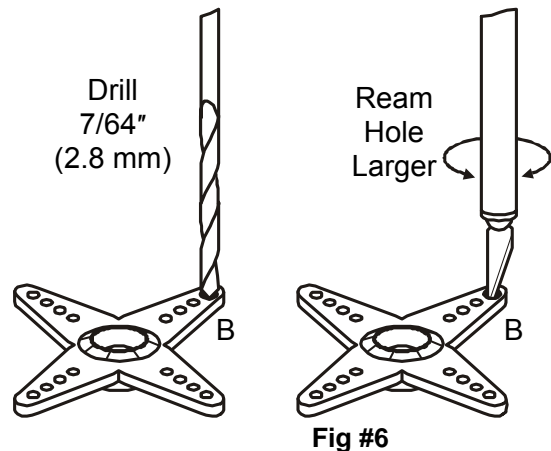

Use **Fig #6** as a guide. The Servo Horns (B) need to have one of the outside holes enlarged. If you do not have a 7/64" drill bit you can enlarge the hole with a hobby knife. When using a knife, carve from each side to keep the hole even. Make the hole a little smaller than the screw so that threads will be made when the screw goes in. Compare your work to **Fig #7** then proceed to **Step #4**.



Step #4 Assembling Middle Legs

Item	Qty	Description
(B)	(2)	Servo Horns
(E)	(4)	Nylon Washers
(F)	(2)	3 mm (1/8") Nylon Spacer
(G)	(4)	Push Arms
(J)	(2)	M3x18 Phillips Pan Head Screws
(N)	(2)	Nylon Insert Locknuts
(Q)	(2)	Plastic Screw Covers

Use **Fig #8** as a guide to each assembly of the Middle Legs. Insert screw (J) through screw cover (Q). Next insert screw through hole of Push Arm (G). Add a washer (E), another Push Arm (G), then another Nylon Washer (E). Insert the screw through the hole of the Middle Leg (O), then add the Nylon Spacer (F). Screw into the large hole on Servo Horn (B). The Screw will make its own threads going into the Servo horn. Tighten until all parts can still rotate freely but are not sloppy. Next screw Locknut (N) onto Screw (J) until snug against the Servo Horn (See **Fig #9**). Before continuing, position the pieces exactly as they appear in **Fig #9**. Double check your work then proceed to **Step #5**.

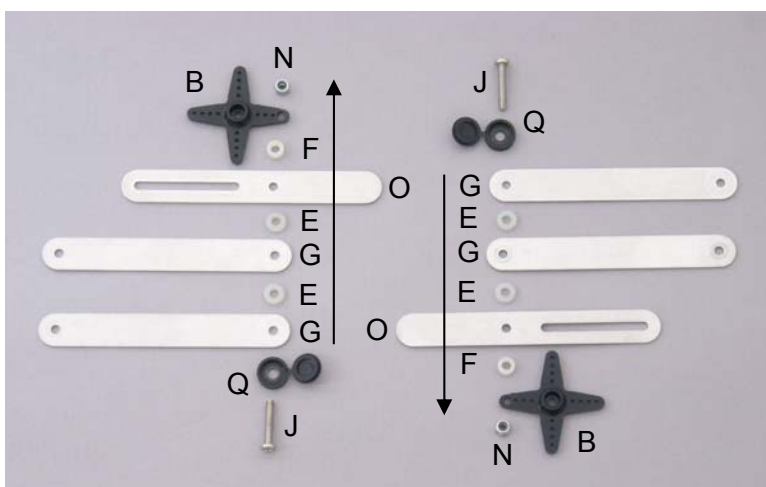

Step #5 Installing Middle Legs

Item	Qty	Description
(K)	(2)	3Mx12 Phillips Pan Head Screw
(Q)	(2)	Plastic Screw Covers

Use **Fig #10** as a guide to install the middle leg assembly just built.

Insert Screws (K) through Screw Covers (Q). Insert the Screw through the long slide hole of the Leg assembly. Screw into standoff (H). Tighten until each leg can slide freely but is not sloppy. Before moving on, position the pieces exactly as they appear in **Fig #11** with the top Push Arm to the right. Double check your work then proceed to **Step #6**.

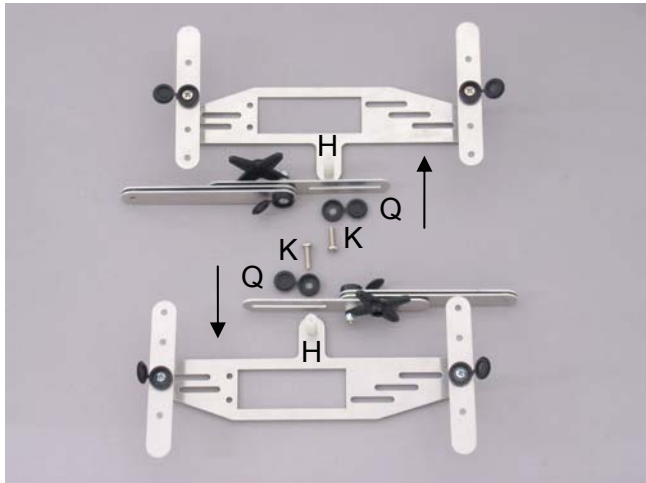

Fig #10

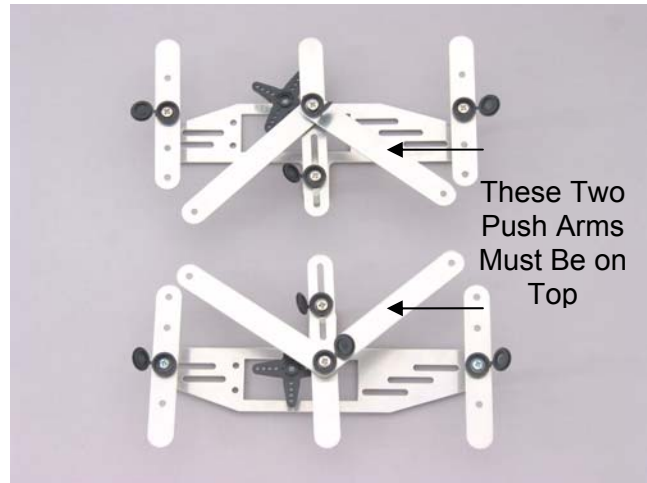

Fig #11

Step #6 Connecting Push arms to Legs

Item	Qty	Description
(E)	(8)	Nylon washers
(L)	(4)	M3x10 Phillips Pan Head Screw
(N)	(4)	Nylon Lock Nuts
(Q)	(4)	Plastic screw covers

Use **Fig #12** as a guide to connect push Arms (G) to Legs (C). Be sure Push Arms are aligned as shown in **Fig #11**. Insert screws (L) through screw covers (Q). Next insert screw through hole of Leg (C), then through a Nylon Washer (E), and through the push arm (G). Next insert the screw through another Nylon Washer and tighten with a Locknut (N) from back of the Push Arm. Tighten until legs can just move freely but are not sloppy. Before moving on, position the pieces exactly as they appear in **Fig #13** and **Fig #14**. Double check your work then proceed to **Step #7**.

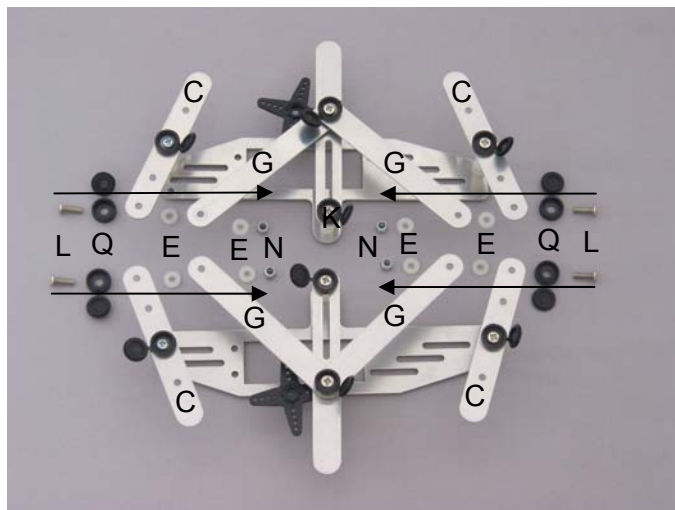

Fig #12



Fig #13



Fig #14

Step #7 Installing the Rubber Feet

<u>Item</u>	<u>Qty</u>	<u>Description</u>
(D)	(6)	Rubber Feet

Use **Fig #15** as a guide to install the rubber feet. Be careful not to bend the legs. Slide the rubber feet (D) onto each Leg as shown in **Fig #16**. Double check your work then proceed to **Step #8**.

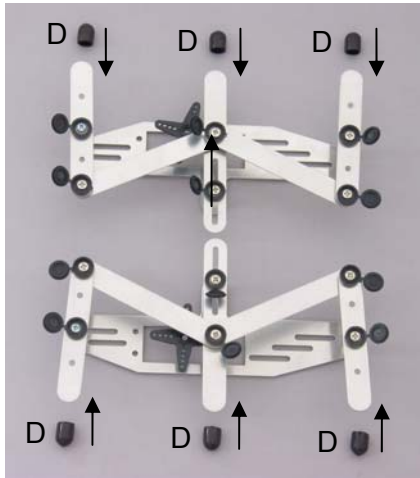

Fig #15



Fig #16

Step #8 Preparing your Boe-Bot

<u>Item</u>	<u>Qty</u>	<u>Description</u>
	(1)	Your Boe-Bot

Use **Fig #17** as a guide. To complete the Crawler Kit upgrade, some simple changes must be made to your Boe-Bot. First, remove the wheels and ball caster. Then, remove your Board of Education® project platform to prevent the chance of damaging it during the installation, and save the screws for the final step. Next compare your servo installation to **Fig #17**. If your servos are installed inside the Boe-Bot chassis, they must be removed and reinstalled as shown. Make sure the servo head is toward the middle of the chassis then proceed to **Step #9**



Fig #17

Step #9 Install Crawler Sides

Item	Qty	Description
(P)	(6)	M3x6 Philips Pan Head Screws
(M)	(6)	M3 Hex Nuts
	(2)	Servo Horn Screws (from your servos)

Use **Fig #18** as a guide.

Line up the Crawler Side Panels to your Boe-Bot and slip the Servo horn on the servo. Secure the Crawler Panels with Screws (P) and Nuts (M). Screw in the Servo Horn screw back into the Servo Horn. Compare your work to **Fig #19-21**. Close the screw covers then proceed to **Step 10**.

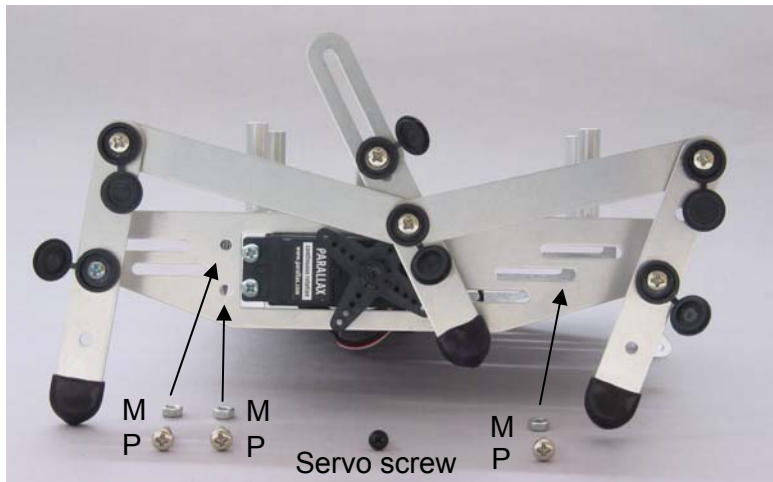

Fig #18

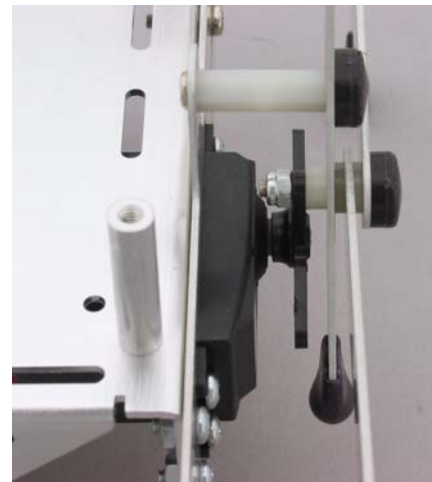

Fig #19



Fig #20



Fig #21

Step #10 Install the Board of Education

<u>Item</u>	<u>Qty</u>	<u>Description</u>
	(1)	Board of Education platform
	(1)	Assembled Walker Kit
	(4)	Screws, from your robot

Use **Fig #22** as a guide. Line up the holes in your Board of Education® project platform with the standoffs on the chassis and secure with screws. Next connect the servos to the servo ports.

Congratulations, assembly is complete!



Fig #22

Troubleshooting your Crawler

The Crawler has been designed to be straightforward and very reliable. The information below will provide helpful assistance to troubleshoot the Crawler. This section covers the most common problems you might encounter.

Legs bind when walking

Check all joints and loosen as needed. Joints should always move freely without being too loose.

Legs hit when walking

Improper assembly of unit or legs bent. Legs should never hit each other while moving.

The Crawler can run any PBASIC program written for the Boe-Bot™ robot. However, since the ground speed of a rolling wheel and the ground speed of the crawler legs may be different, some programs that send a wheeled Boe-Bot a certain distance or execute a turn of certain number of degrees may need to be adjusted. Any navigation routine for a specific maneuver can be easily adapted by changing the FOR...NEXT loop *EndValue* arguments.